



INSTALLATION INSTRUCTIONS
AIR INTAKE KIT
2011-2016 CHRYSLER 300 3.6L V6
2011-2016 DODGE CHARGER 3.6L V6
2011-2016 DODGE CHALLENGER 3.6L V6
PART NUMBER 77070045AB

Bill of Materials for 77070045AB

A	1	9-0398	MOPAR Air Box
B	1	MP-M-1011	Air Filter Assembly
C	1	102507	Rubber Edge Trim 30-1/2"
D	1	27368M	Air Filter Adaptor Tube
E	1	8-184	Elbow; Reducer 3/4" - 5/8"
F	5	08373	M6 Bolt
G	1	081004	Aluminum Threaded Boss
H	1	8-183	Blanking Plug
I	3	9456	Hose Clamp, #56
J	1	08656	Elbow Hose 3.25" - 3.15" ID
K	1	08657	Hump Hose 3.25"-3.5" ID
L	1	27365M	MOPAR Air Intake Tube; Throttle Body
M	1	27366M	MOPAR Air Intake Tube; Air Box
N	1	08654	Straight Hose 3.5" ID
O	1	784634	1/2" ID Grommet
P	3	9452	Hose Clamp #52
Not shown	1	L77070045	Installation Instructions



INSTALLATION INSTRUCTIONS
AIR INTAKE KIT
2011-2016 CHRYSLER 300 3.6L V6
2011-2016 DODGE CHARGER 3.6L V6
2011-2016 DODGE CHALLENGER 3.6L V6
PART NUMBER 77070045AB

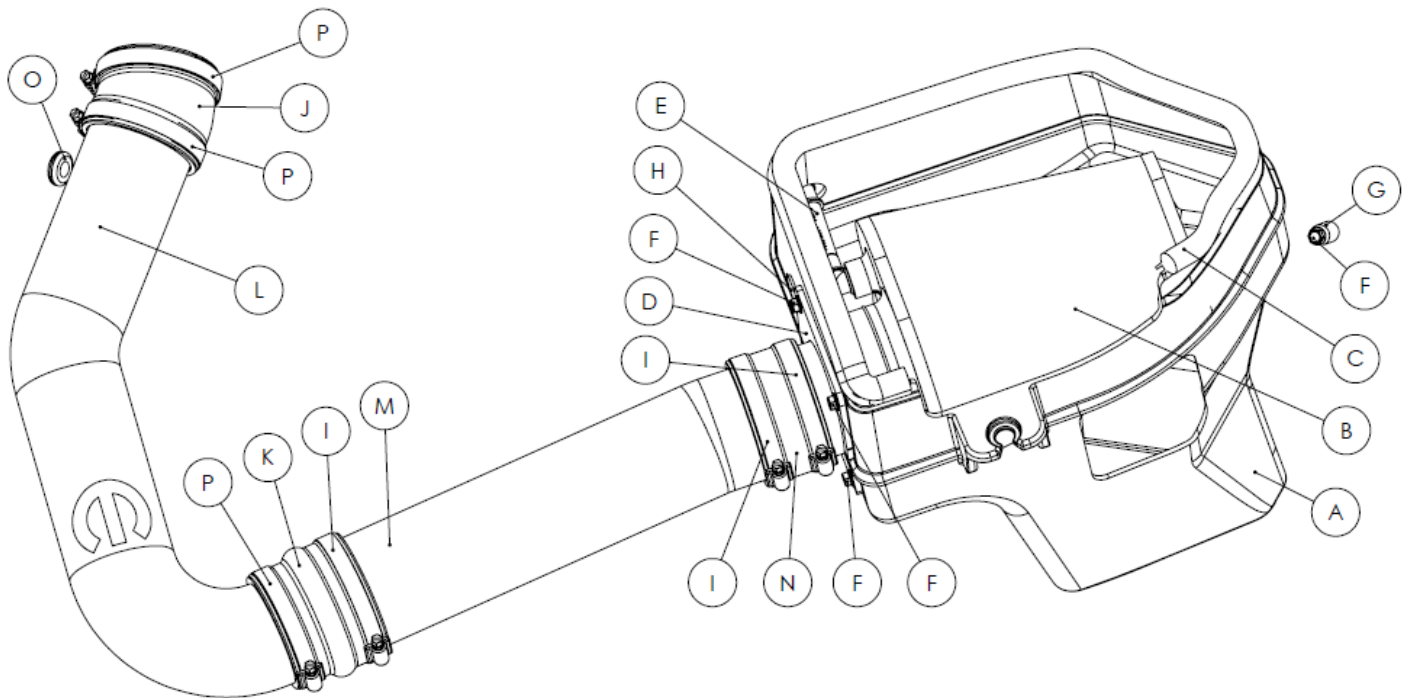



INSTALLATION INSTRUCTIONS
AIR INTAKE KIT
2011-2016 CHRYSLER 300 3.6L V6
2011-2016 DODGE CHARGER 3.6L V6
2011-2016 DODGE CHALLENGER 3.6L V6
PART NUMBER 77070045AB



IMPORTANT:

This kit includes a high-performance DRYFLOW Air Filter.

DO NOT APPLY ANY OIL TO THIS FILTER! See Step 5 for cleaning instructions.

Read and understand these instructions **BEFORE** attempting to install this product.

1) Getting Started

- a) If engine has run within the past two hours, open the hood and allow it to cool down.
- b) Make sure the vehicle is parked on a level surface.
- c) Set the parking brake.
- d) Disconnect the negative battery terminal.
- e) Open the air intake kit package and make sure all parts are included.

2) Removal of the stock intake system



a) Your stock air intake system should look like this.



b) Remove the engine cover by pulling straight up.



INSTALLATION INSTRUCTIONS
AIR INTAKE KIT
2011-2016 CHRYSLER 300 3.6L V6
2011-2016 DODGE CHARGER 3.6L V6
2011-2016 DODGE CHALLENGER 3.6L V6
PART NUMBER 77070045AB

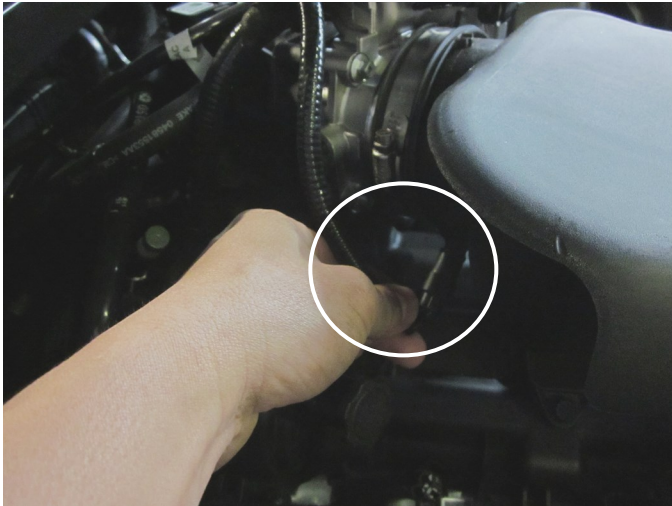

c) Release the wire harness clip to the IAT (intake air temp) sensor by gently pressing the tab.

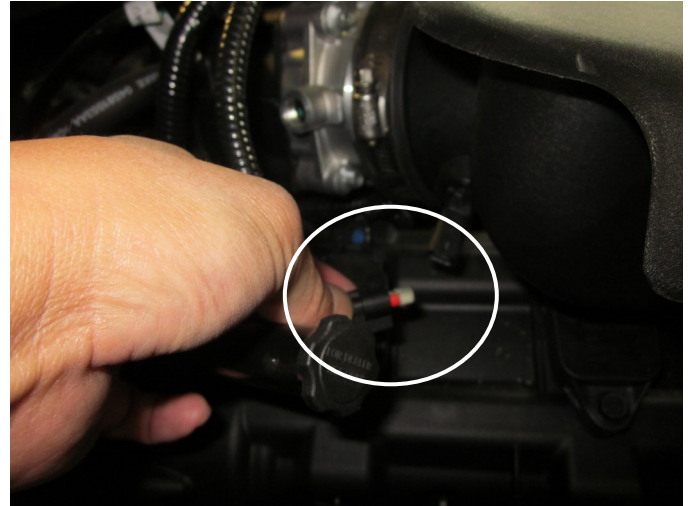

d) With the tab depressed, detach the clip from the IAT sensor. Do not remove the sensor at this time.

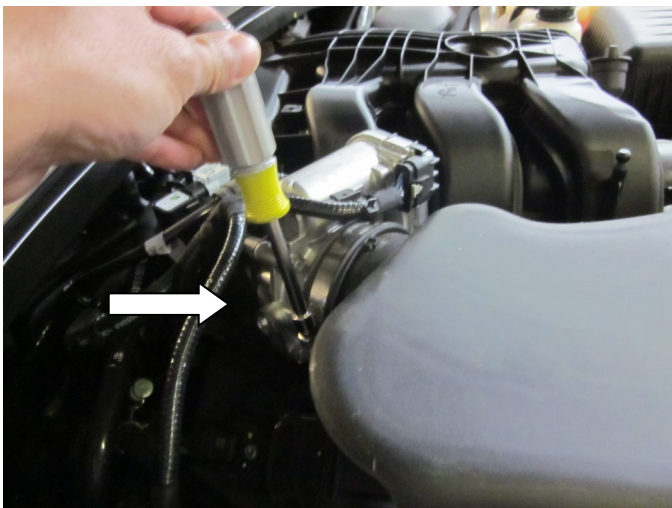

e) Loosen the hose clamp at the throttle body.



f) Loosen the hose clamp at the air box.



INSTALLATION INSTRUCTIONS
AIR INTAKE KIT
2011-2016 CHRYSLER 300 3.6L V6
2011-2016 DODGE CHARGER 3.6L V6
2011-2016 DODGE CHALLENGER 3.6L V6
PART NUMBER 77070045AB



g) Detach and remove the factory air intake hose from the throttle body and air box.



h) Detach the valve cover breather hose from the air box that will be reused in step 3n).



i) Loosen and remove the M6 bolt securing the air box. The M6 bolt will be reused in step 3j).



j) Pull the air box straight up to remove it from the engine bay.



INSTALLATION INSTRUCTIONS
AIR INTAKE KIT
2011-2016 CHRYSLER 300 3.6L V6
2011-2016 DODGE CHARGER 3.6L V6
2011-2016 DODGE CHALLENGER 3.6L V6
PART NUMBER 77070045AB

3) Installation of MOPAR Air Intake System

NOTE: When installing the MOPAR Air Intake System, DO NOT completely tighten the hose clamps or mounting hardware until instructed to do so. Check to see that the inside of the inlet tubes and air filter are clean and free from any foreign objects and/or obstructions



b) Remove the rubber grommet from the factory air box. The grommet will be reinstalled on the MOPAR air box in step 3d).



c) Remove the rubber bushing from the bottom of the factory air box. The rubber bushing will be reinstalled onto the MOPAR air box in step 3f).



d) Install the rubber grommet removed from step 3b) into the MOPAR air box.

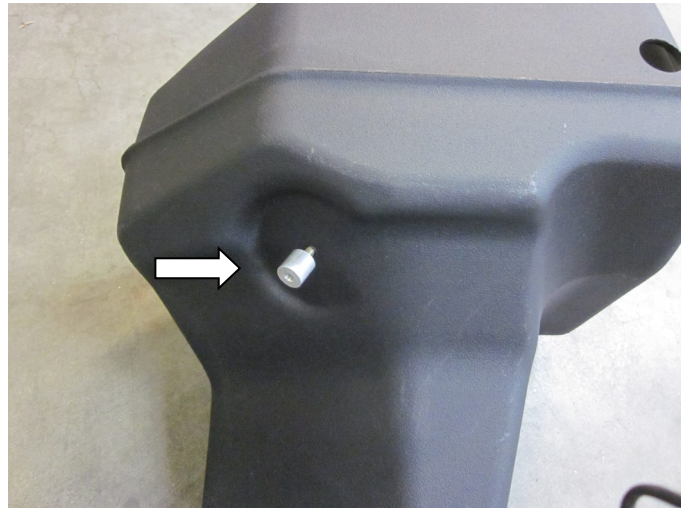

e) Install the supplied aluminum threaded boss to the bottom of the MOPAR air box with a M6 bolt and tighten to 4.0Nm (35.4 in/lb).



INSTALLATION INSTRUCTIONS
AIR INTAKE KIT
2011-2016 CHRYSLER 300 3.6L V6
2011-2016 DODGE CHARGER 3.6L V6
2011-2016 DODGE CHALLENGER 3.6L V6
PART NUMBER 77070045AB

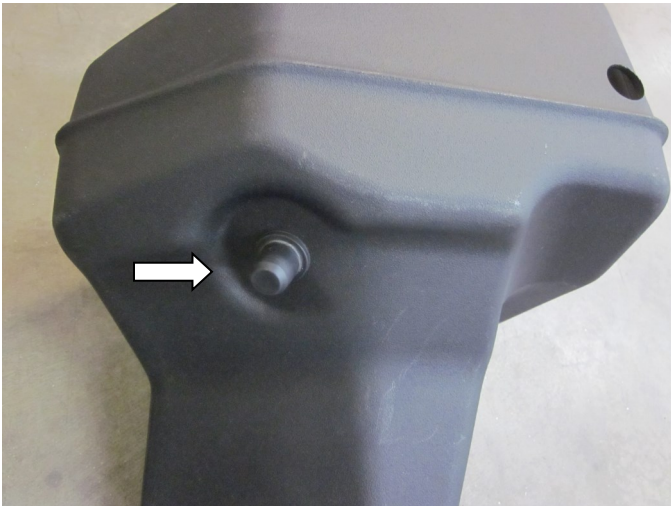

f) Install the rubber bushing removed in step 3c) onto the aluminum threaded boss installed in step 3e).

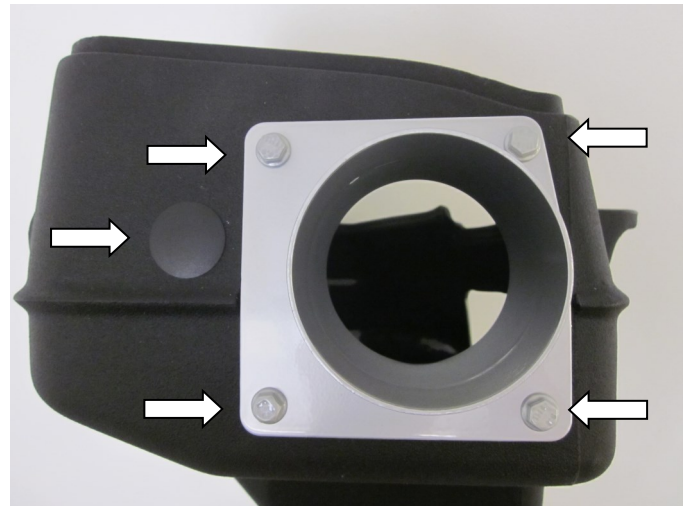

g) Install the air filter adaptor on the MOPAR cold air box with (4) supplied M6 bolts with red threadlocker and tighten to 3.5Nm (31 in/lb) and install the blanking plug in the unused hole next to the filter adaptor.

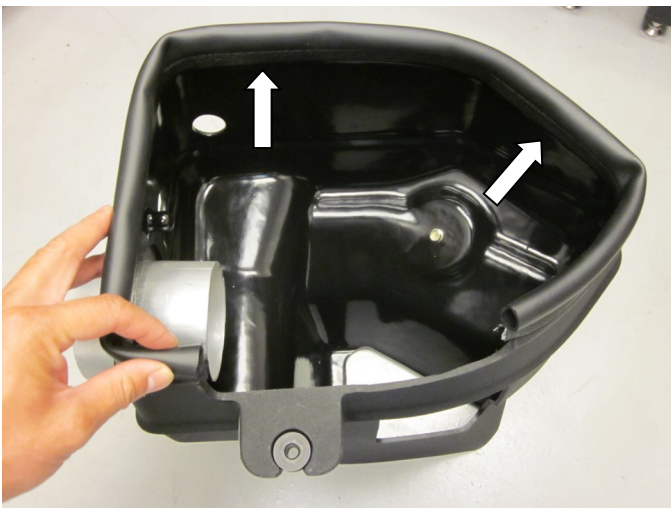

h) Install the supplied rubber edge trim around the top opening of the MOPAR air box.

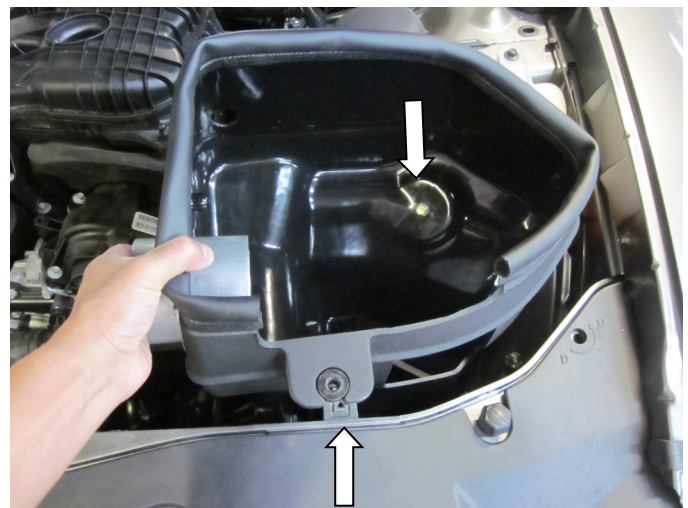

i) Install the MOPAR air box into the engine bay. **Note:** Make sure the rubber grommet lines up with the tab on the core support and the rubber bushing is fully seated to the inner fender.



INSTALLATION INSTRUCTIONS
AIR INTAKE KIT
2011-2016 CHRYSLER 300 3.6L V6
2011-2016 DODGE CHARGER 3.6L V6
2011-2016 DODGE CHALLENGER 3.6L V6
PART NUMBER 77070045AB



j) Secure the MOPAR cold air box to the core support with the factory M6 bolt removed from step 2i) and tighten to 3.5Nm (31 in/lb)



k) Locate the 8-184 reducer elbow fitting.



l) Insert the hose-fitting assembly into the air filter and install the air filter into the MOPAR air box.



m) Adjust and align the air filter assembly for clearance then tighten the hose clamp to 3.0Nm (26.5 in/lb). The vent fitting will go through the cut out in the air box.



INSTALLATION INSTRUCTIONS
AIR INTAKE KIT
2011-2016 CHRYSLER 300 3.6L V6
2011-2016 DODGE CHARGER 3.6L V6
2011-2016 DODGE CHALLENGER 3.6L V6
PART NUMBER 77070045AB



n) Connect the valve cover breather hose to the vent fitting from the air box that was removed in step 2h).

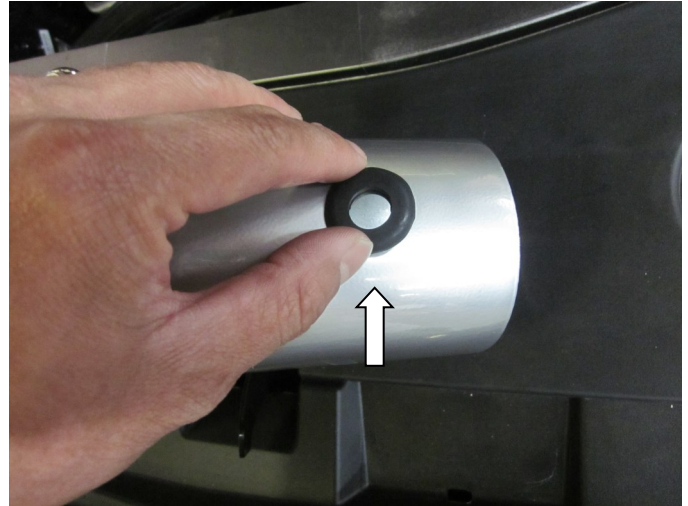

o) Locate the throttle body air intake tube and install the supplied rubber grommet into the hole.

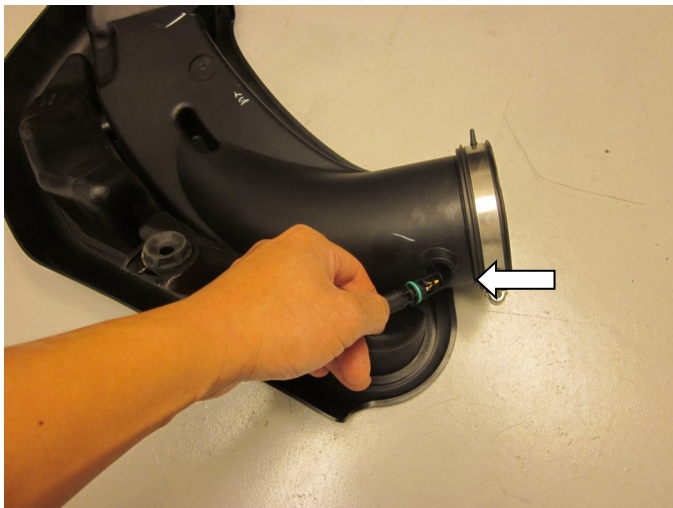

p) Locate the IAT (intake air temperature) sensor on the factory air intake hose. Twist and pull to remove it from the tube.



q) With a suitable tool such as a pick, remove the O-ring from the IAT sensor. **Note: Do not discard the O-Ring, however it will not be reused.**



INSTALLATION INSTRUCTIONS
AIR INTAKE KIT
2011-2016 CHRYSLER 300 3.6L V6
2011-2016 DODGE CHARGER 3.6L V6
2011-2016 DODGE CHALLENGER 3.6L V6
PART NUMBER 77070045AB



r) Insert the IAT sensor into the grommet so the sensor probe is in the air flow path as shown. **Note: the orientation of the sensor probe inside the tube does not affect performance.**

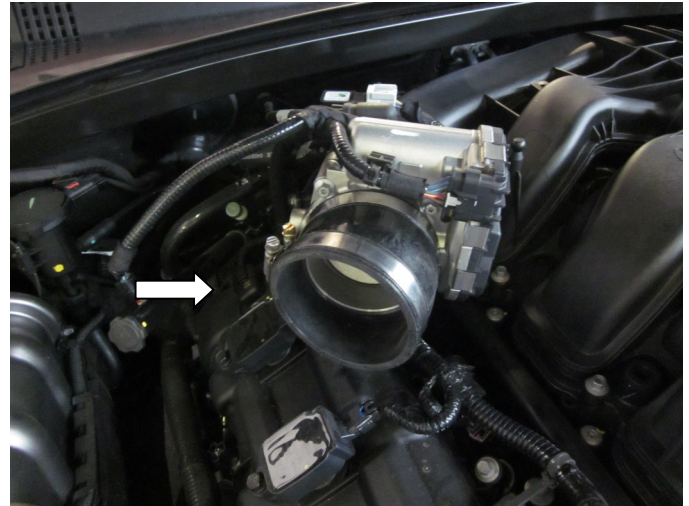

s) Install the supplied angled hose adaptor and (2) #52 hose clamps onto the throttle body as shown and tighten to 3.0Nm (26.5 in/lb). **Note: the smaller end of the hose goes on the throttle body.**

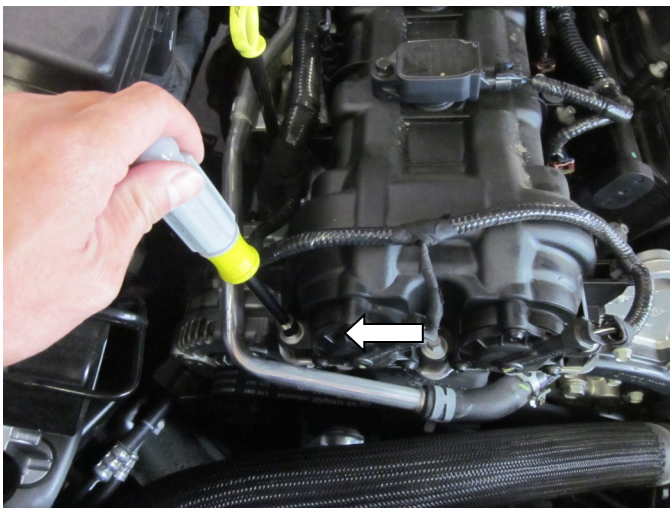

t) Loosen but do not remove the M6 bolt on the passenger side valve cover.

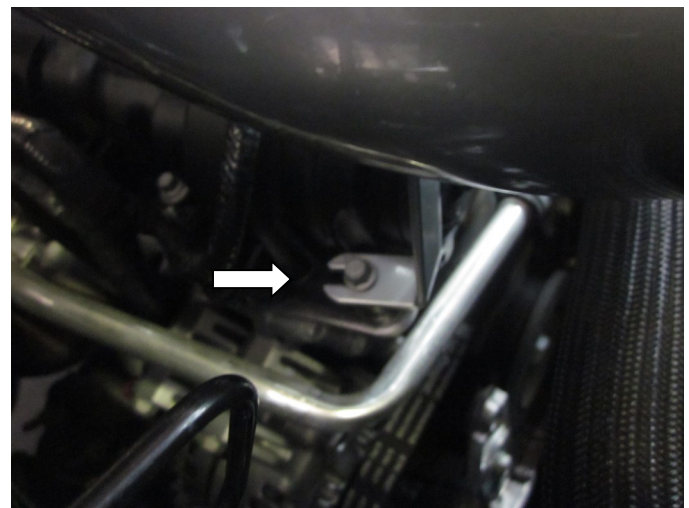

u) Install the throttle body air intake tube to the throttle body hose and slide the support bracket between the M6 bolt and valve cover. **Note: Do not completely tighten the M6 bolt until desirable tube placement is achieved.**



INSTALLATION INSTRUCTIONS
AIR INTAKE KIT
2011-2016 CHRYSLER 300 3.6L V6
2011-2016 DODGE CHARGER 3.6L V6
2011-2016 DODGE CHALLENGER 3.6L V6
PART NUMBER 77070045AB

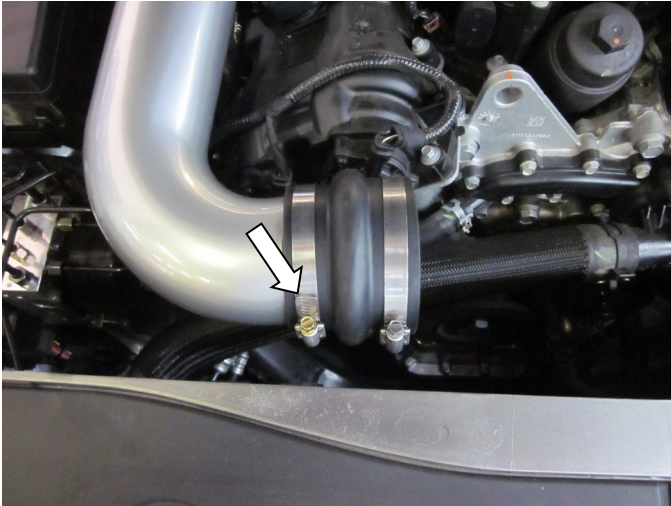

v) Install the 3 ¼" ID end of the supplied hump hose onto the throttle body air intake tube along with a #52 and #56 hose clamp and tighten the clamp on the tube side to 3.0Nm (26.5 in/lb).

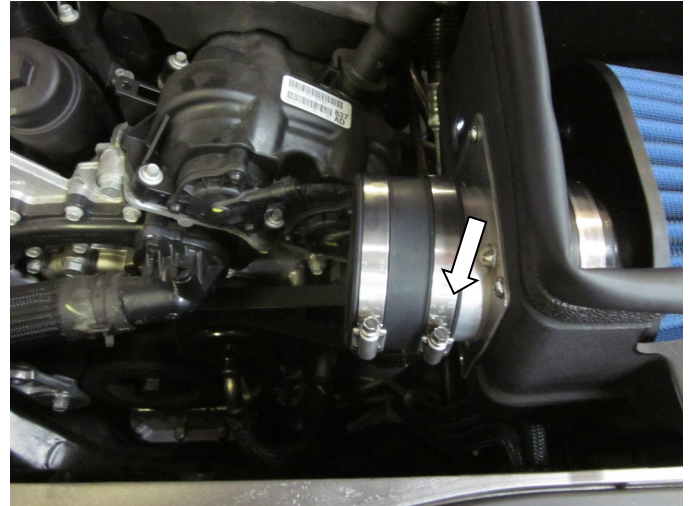

w) Install the 3 ½" ID straight hose onto the air filter adaptor along with (2) #56 hose clamps and tighten the clamp on the adaptor side to 3.0Nm (26.5 in/lb).



x) Install the air box intake tube. Please note that the end with the slight bend goes to the air box and tighten the hose clamps to 3.0Nm (26.5 in/lb) once desired orientation is achieved.

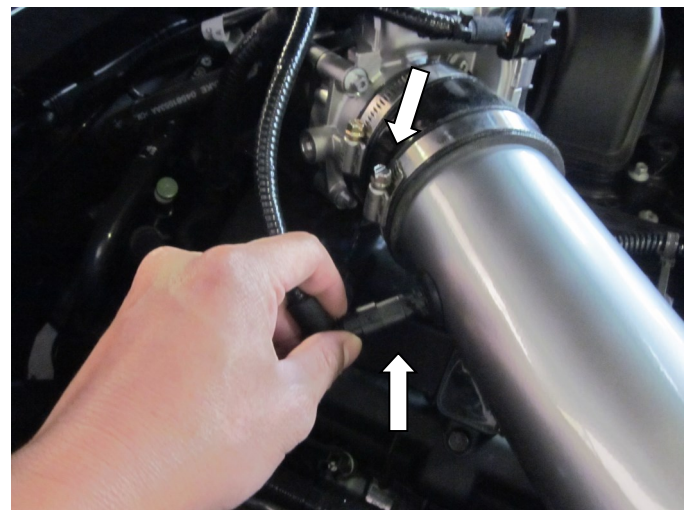

v) Finally, tighten hose clamp to 3.0Nm (26.5 in/lb) and the bracket bolt on the valve cover to 3.5Nm (31 in/lb) and connect the IAT sensor harness that was removed in step 2c) to the IAT sensor.



INSTALLATION INSTRUCTIONS
AIR INTAKE KIT
2011-2016 CHRYSLER 300 3.6L V6
2011-2016 DODGE CHARGER 3.6L V6
2011-2016 DODGE CHALLENGER 3.6L V6
PART NUMBER 77070045AB



w) This is how the MOPAR air intake system should look.



INSTALLATION INSTRUCTIONS
AIR INTAKE KIT
2011-2016 CHRYSLER 300 3.6L V6
2011-2016 DODGE CHARGER 3.6L V6
2011-2016 DODGE CHALLENGER 3.6L V6
PART NUMBER 77070045AB

4) Re-assemble the vehicle

- a) Inspect all MOPAR Air Intake kit components proximity to A/C lines, dip sticks, hoses for ample clearance.
- b) **Tighten all fasteners to 3.5Nm (31 in/lb) and hose clamps to 3.0Nm (26.5 in/lb)**
- c) Inspect the engine bay for any loose tools, and then check that all fasteners are tight, and that the IAT sensor cable is properly connected.
- d) Start the engine and allow it to idle, and then perform a final inspection before driving the vehicle.

5) Cleaning Instructions: MOPAR DRYFLOW Air Filter

(It is recommended that you service your MOPAR air filter every 20,000 miles for optimum performance.)

- a) Remove the air filter from intake system and set the filter clamp aside.
- b) Measure the length of the filter media.
- c) Fill a pail with warm clean water to the depth determined in Step B. Add a mild household detergent or DRYFLOW air filter cleaning solution to the water.
- d) Without allowing the solution to flow into the filter neck, submerge the filter into the water and let it soak for 10 minutes. After soaking, rotate the filter back and forth to agitate the water and knock off dirt.
- e) Empty the bucket of dirty water. Repeat steps C and D.
- f) Refill the pail with clean warm water and rinse by rotating the filter as in step D. The water should be clear with no signs of dirt in the pail.
- g) Allow the filter to air dry. Re-install the filter on the intake system once it is dry.

DO NOT APPLY ANY OIL TO THIS FILTER.

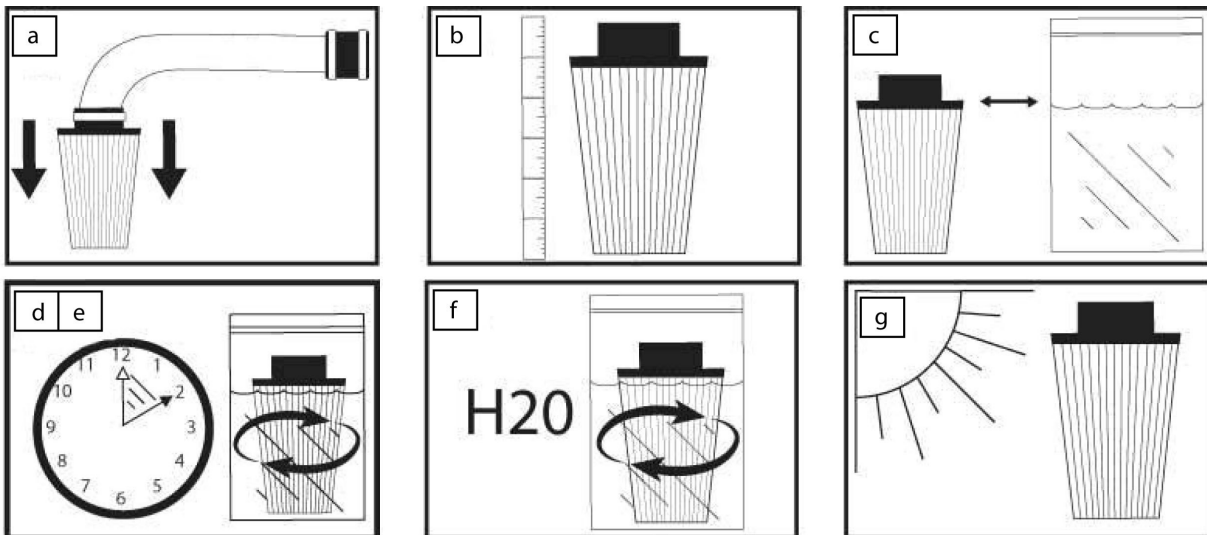

OEM-DOD300

11/16/2015